

-
-
-
-
-
-
-
-
-
-
-

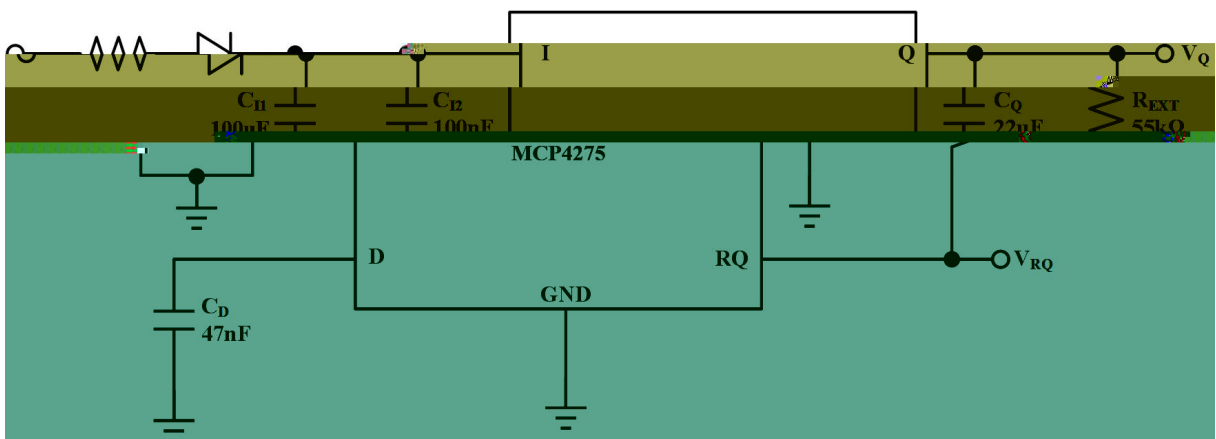

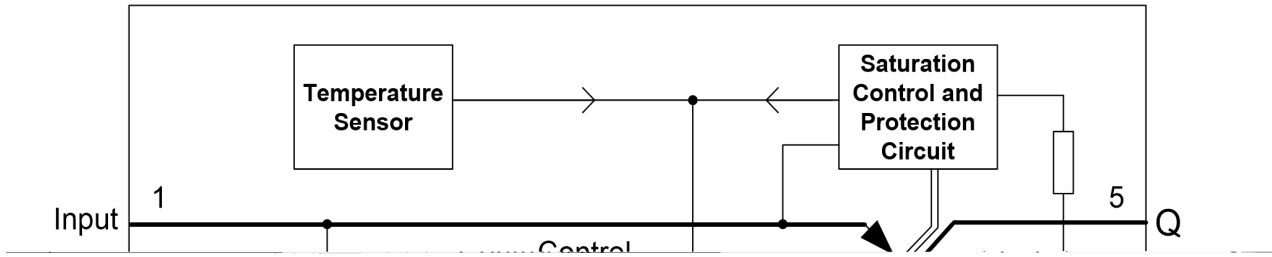

MICHIP

MICHIP

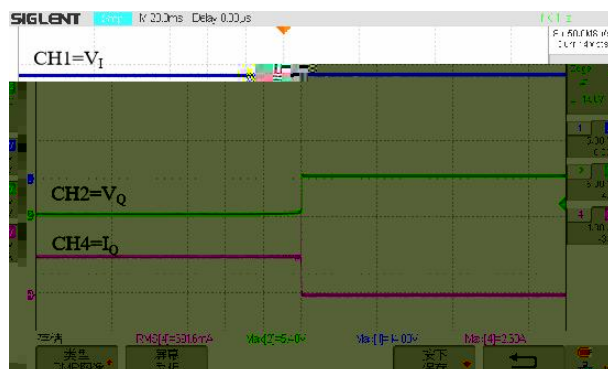
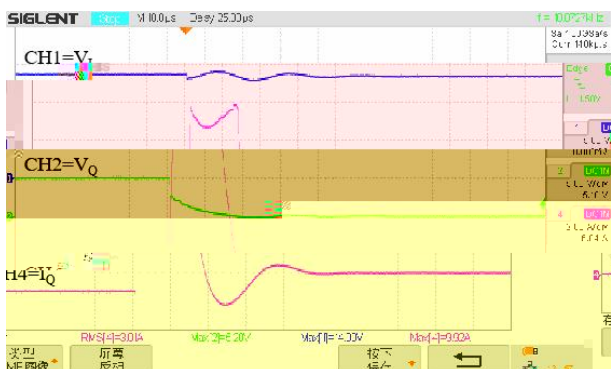
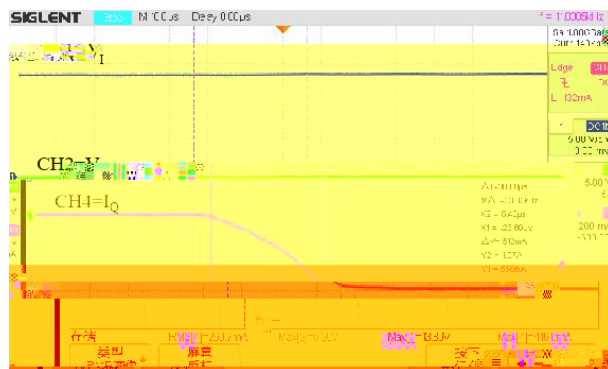
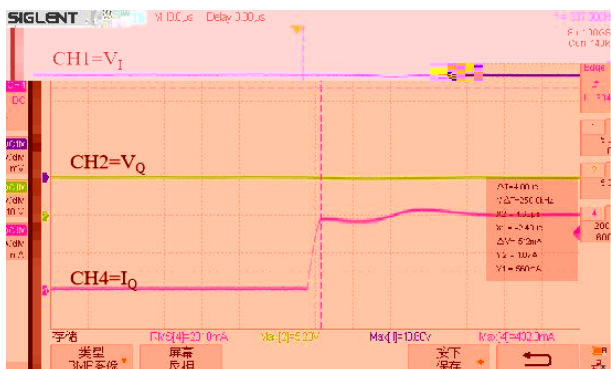

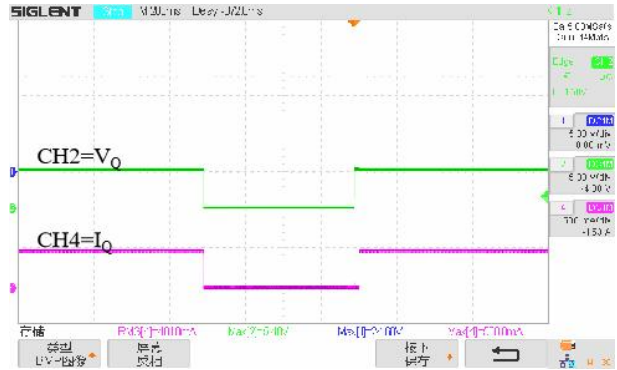
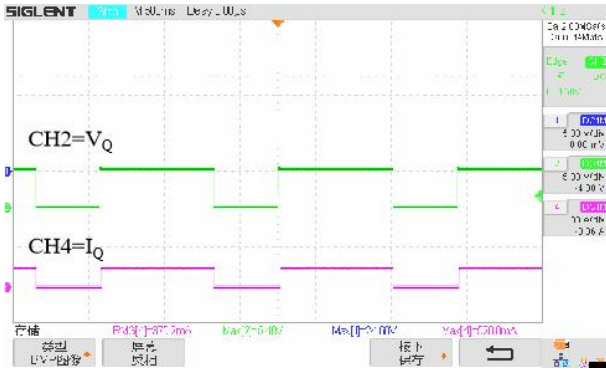

$$t_{rd} = \frac{1.8}{6}$$

