

2

1

1	FB	LED
2	GND	
3	SW	
4	VIN	
5	EN	

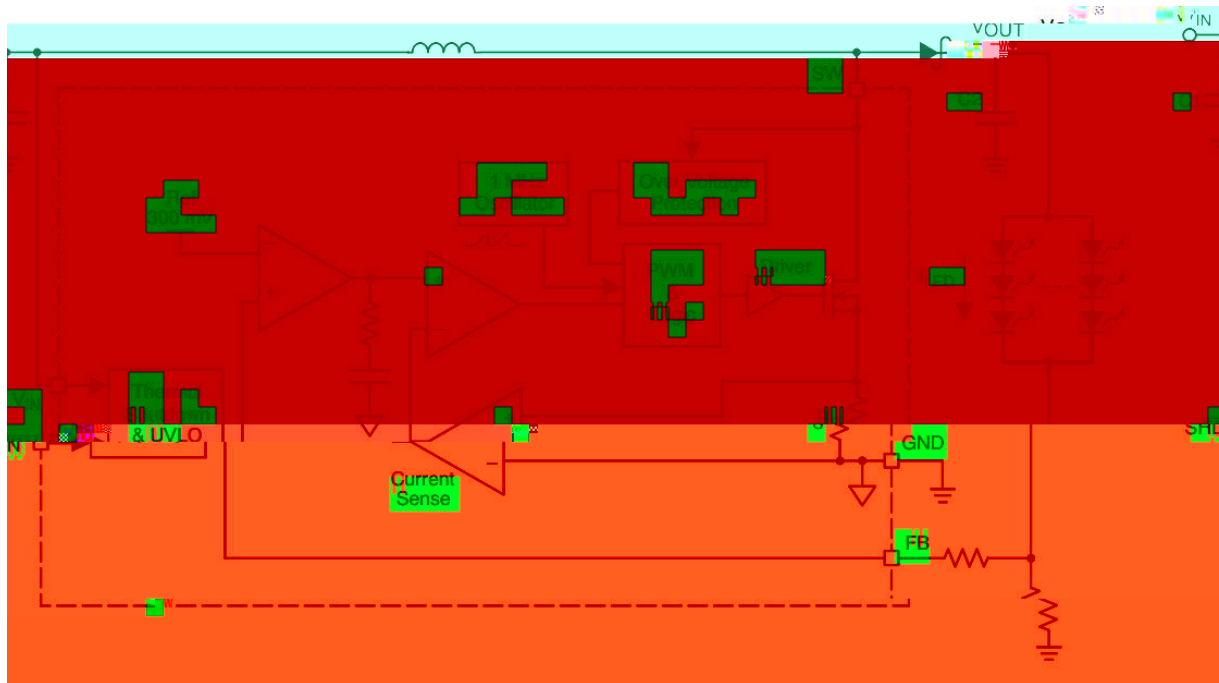

3 MCP9904D

MILCHP

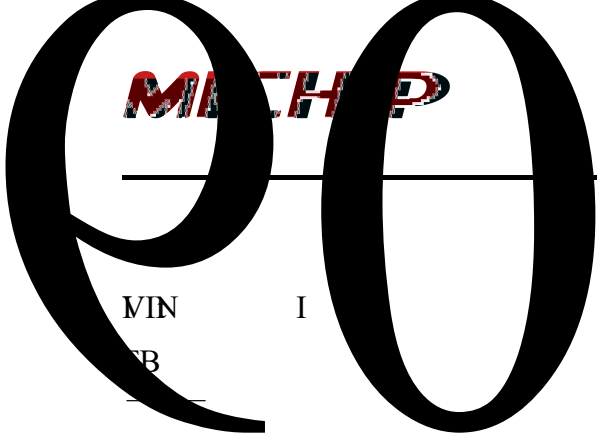

VIN

I

-0.3V 60V

FB

-0.3V 7V

—

-0.3V 60V

SW

-0.3V 60V

P 16

€

#

$V_{IN}=5V$ $T_A = 25$

$T_A=25$

$V_{IN}=5V$ $V_{OUT}=17.1V$ $R_L=100$



$V_{IN}=5V$ $V_{OUT}=17.1V$ $R_L=100$

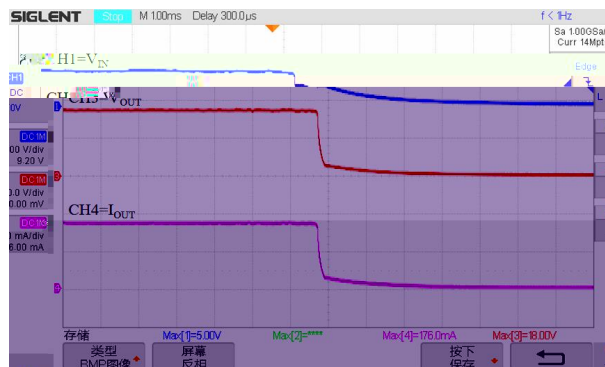

$V_{IN}=5V$ $V_{EN}=0V$ $5V$ $V_{OUT}=17.1V$ $R_L=100$

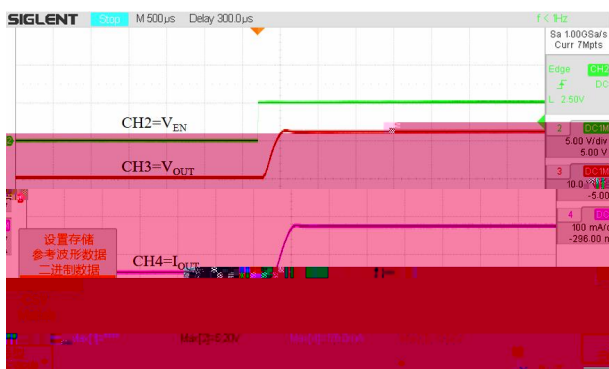

$V_{IN}=5V$ $V_{EN}=5V$ $0V$ $V_{OUT}=17.1V$ $R_L=100$

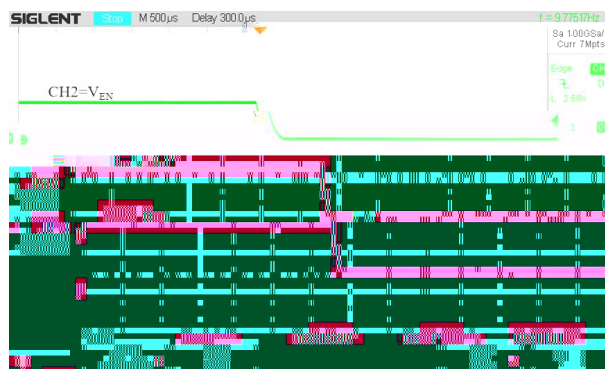

$V_{IN}=5V$ $V_{OUT}=12V$ $R_L=50$

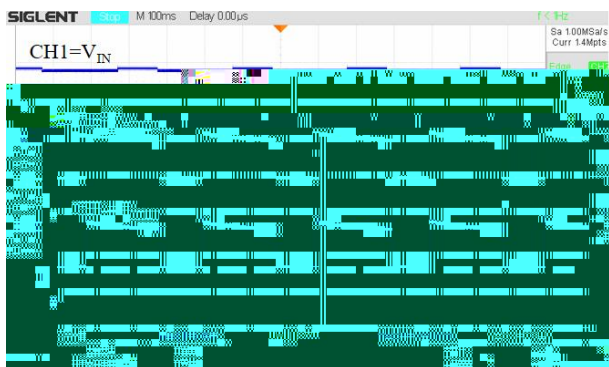

$V_{IN}=5V$ $V_{OUT}=12V$ $R_L=50$



MICHIP

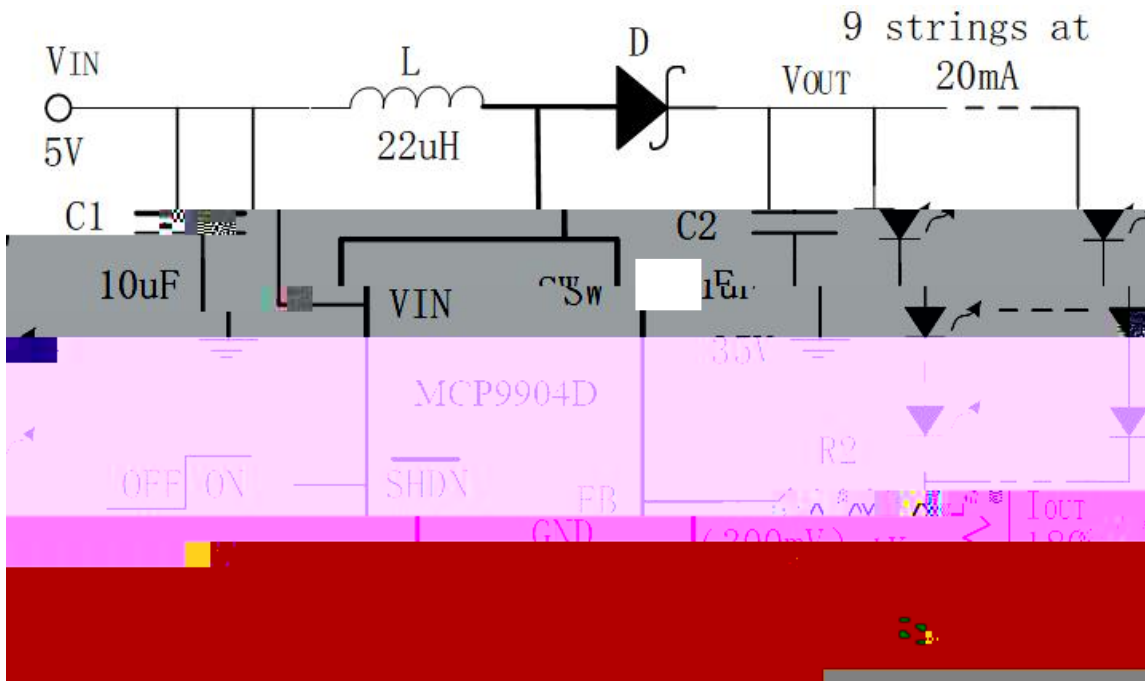
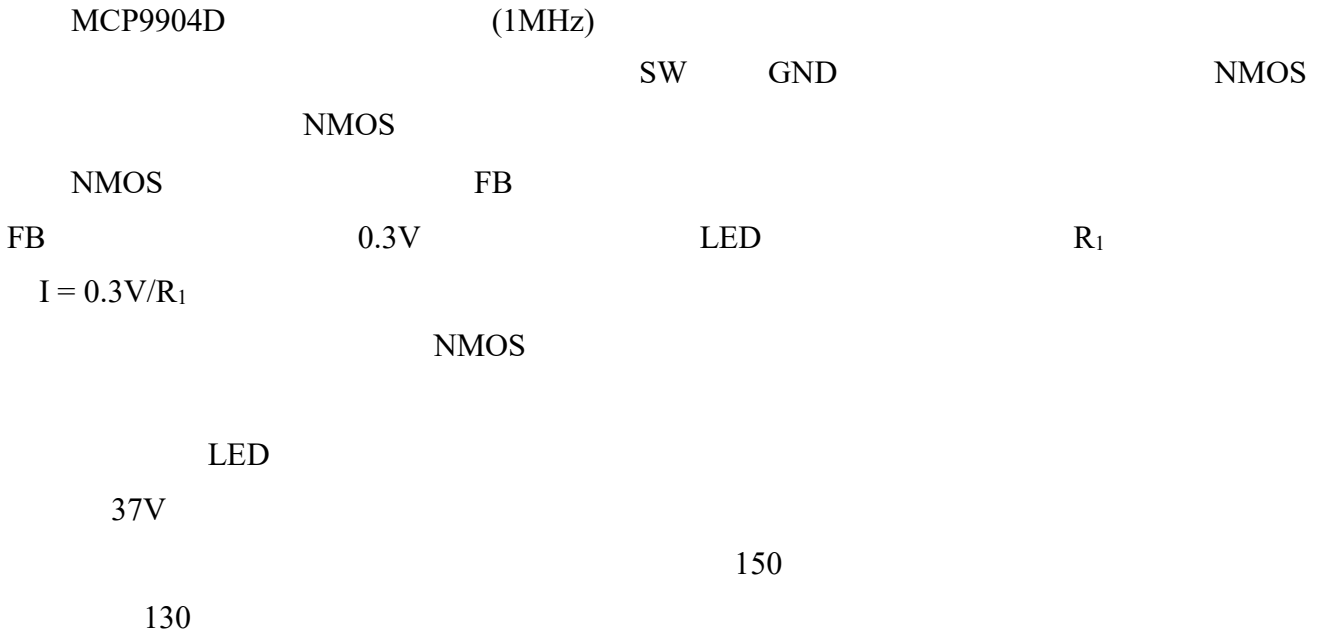

4
 Sumida CDRH6D28-220 22uH 800mA 22uF
 1.2A D.C.R 128m

1MHz Central Semiconductor
 CMSH1-40 1A

LED FB R₁

0.3
 1 ———
 —

20	15
25	12
30	10
100	3
300	1

LED MCP9904D
 37V 37V
 6mW 3.6V 1.6mA SW
 37V VOUT FB 37V
 LED
 FB 0.1V LED SW

LED
 1 PWM LED PWM
 LED 100%
 LED 0.3/R1 7 PWM LED
 1kHz 50% PWM 100Hz
 2kHz

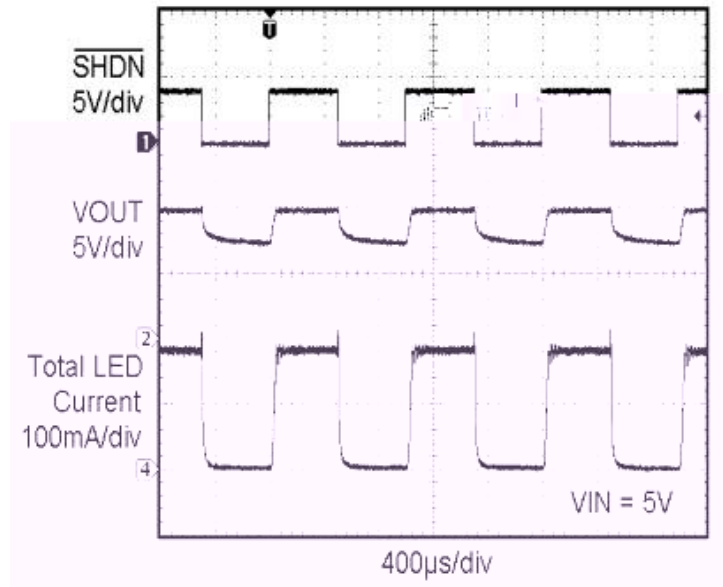

7 1kHz PWM
 2 PWM PWM LED 8
 PWM MCP9904D FB PWM 0V 2.5V
 LED 0mA 20mA PWM
 100kHz

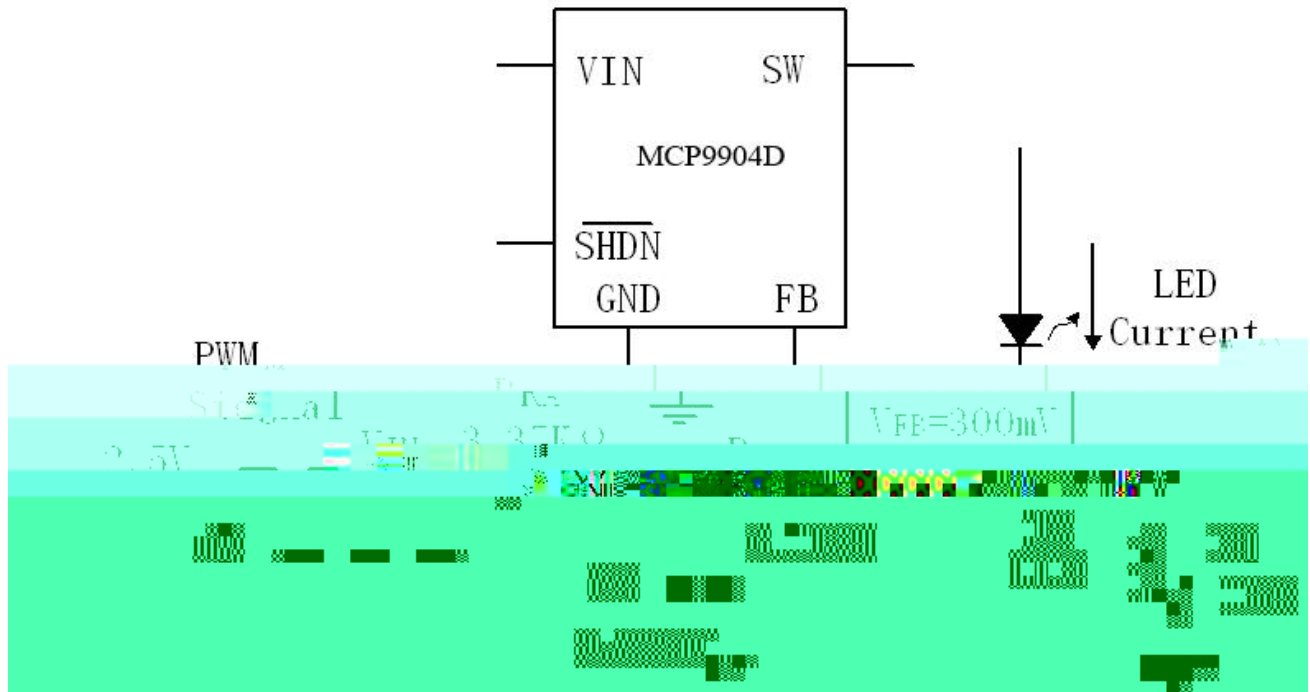

8 PWM

PWM 0V 0% LED 22mA PWM
 93% LED 0mA PWM LED 9



9 PWM 0V 2.5V

MCP9904D

EMI

10

10

MCP9904D

11

MCP9904D

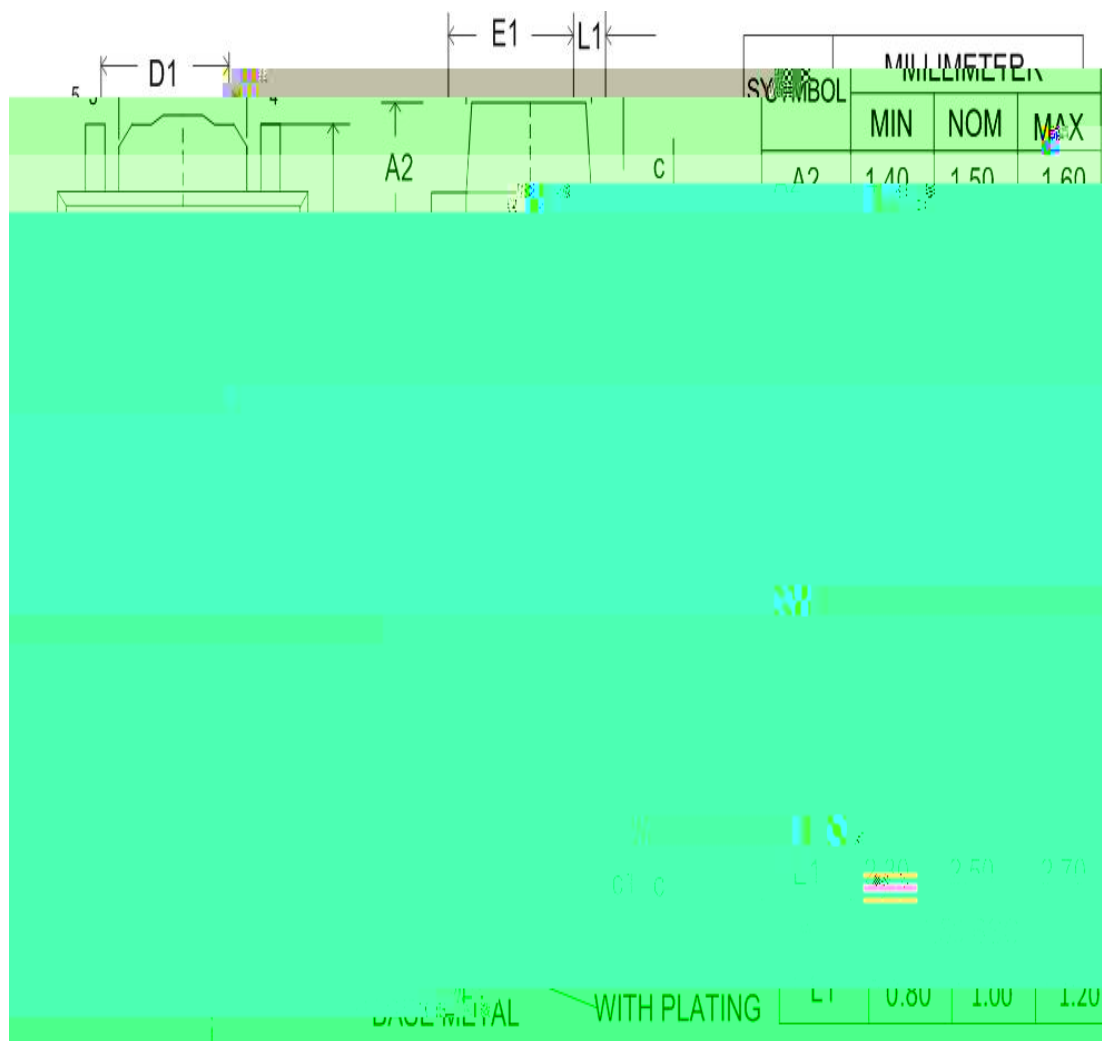

SOT89-5L

MCP9904D	SOT89-5L	1000pcs/Tape&Reel