

MICHIP

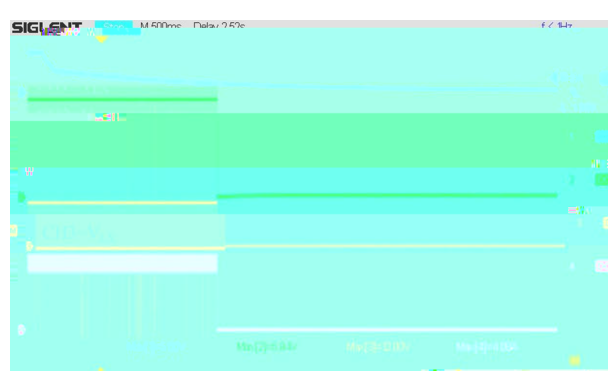

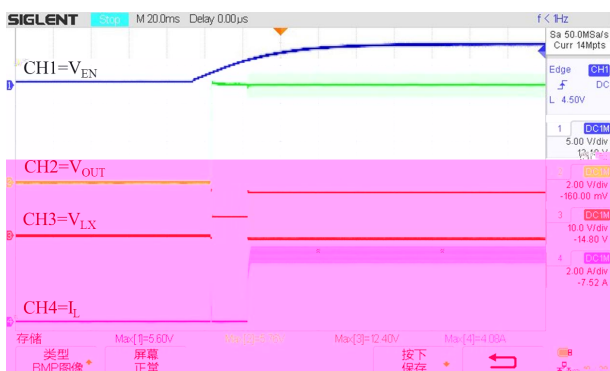

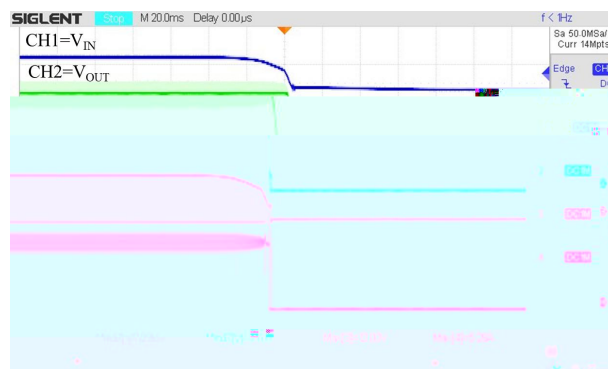
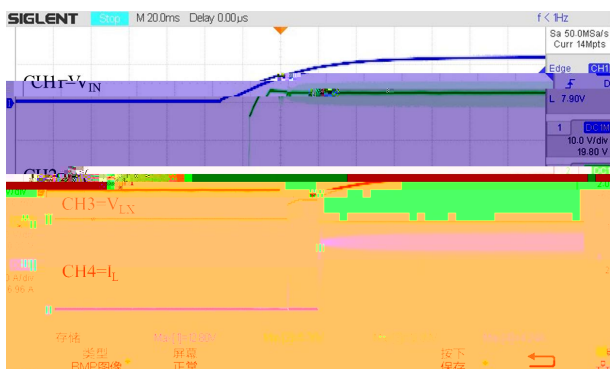
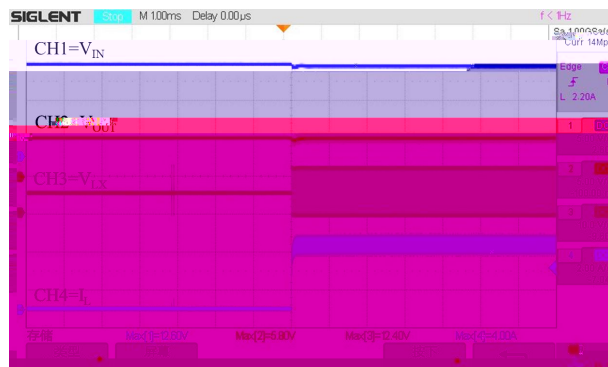
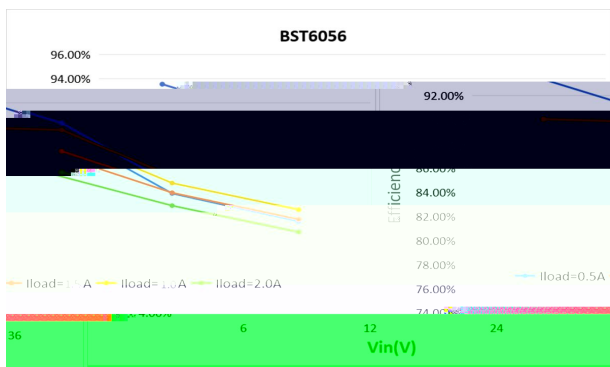
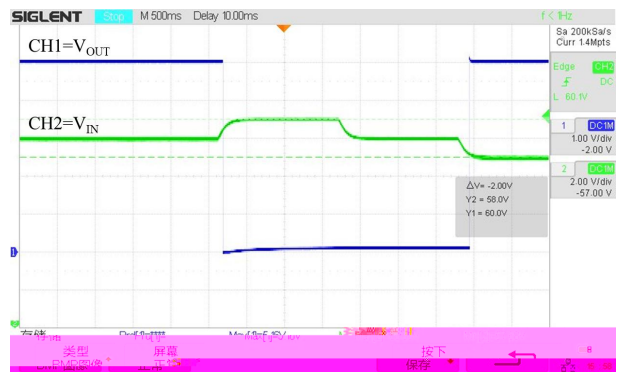
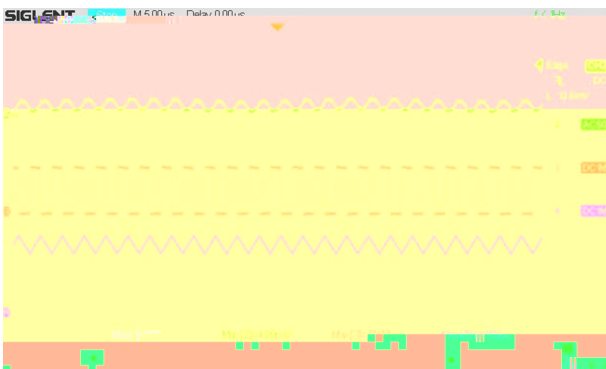
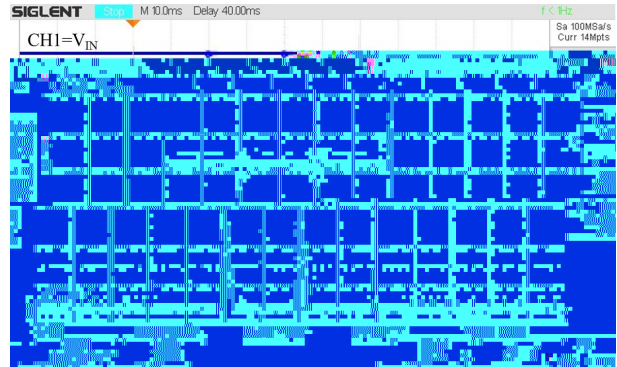
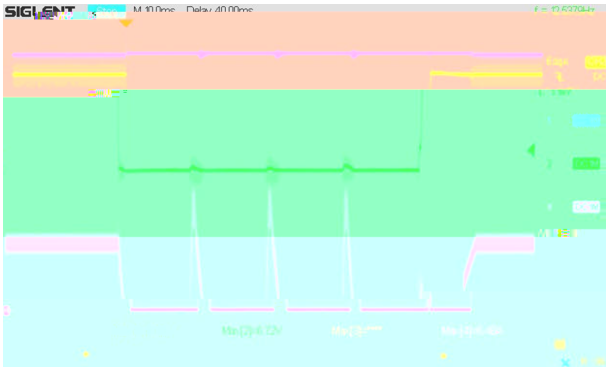
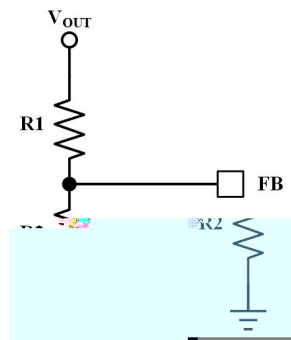

√

()

 ()

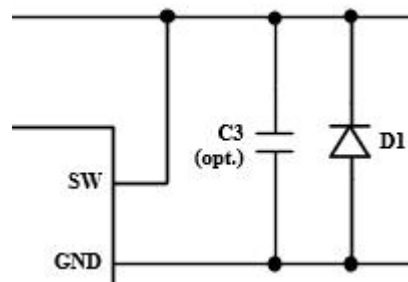
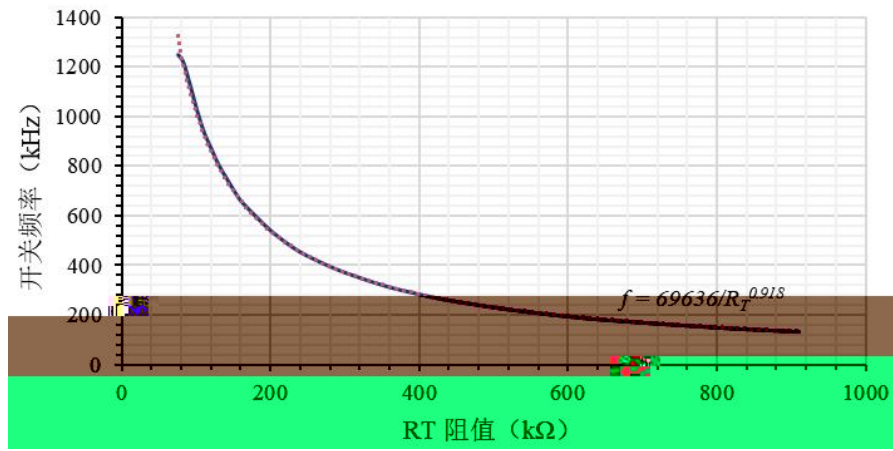

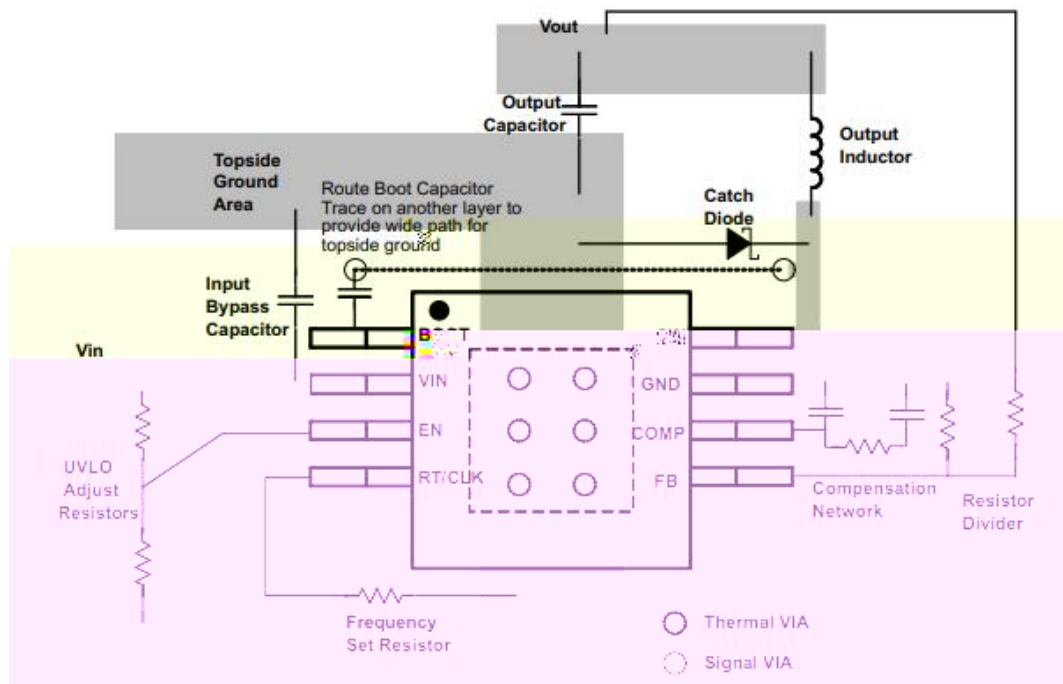

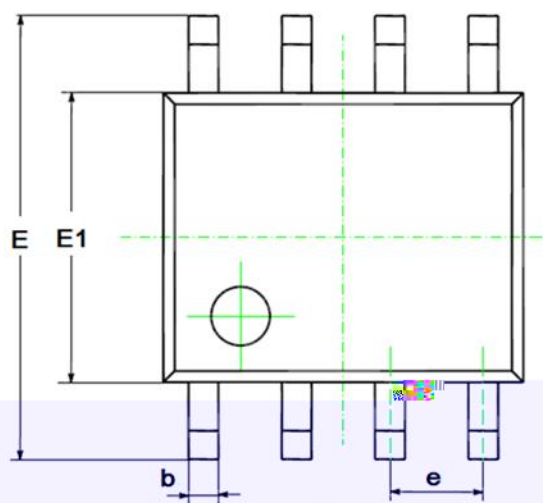

顶视图

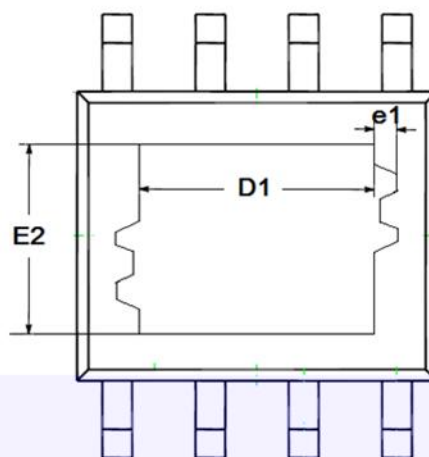

底视图

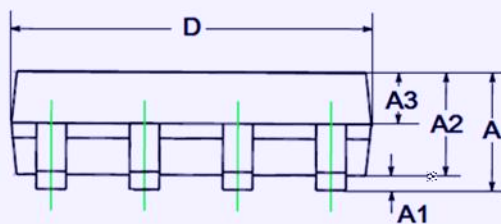

侧视图

符号	毫米		
	最小值	典型值	最大值
A	-	-	1.65
A1	0.05	-	0.15
A2	1.30	1.40	1.50
A3	0.60	0.65	0.70
b	0.39	-	0.48
b1	0.38	0.41	0.43
c	0.21	-	0.25
c1	0.19	0.20	0.21
D	4.70	4.90	5.10
